

DrayTek

Vigor2866 Series

G.Fast Security Firewall



QUICK START GUIDE (RF MODEL)

V1.1

Vigor2866 Series G.Fast Security Firewall Quick Start Guide (for RF Model)

Version: 1.1

Firmware Version: 4.4.1

(For future update, please visit [DrayTek web site](#))

Date: October 19, 2022

Intellectual Property Rights (IPR) Information

Copyrights	© All rights reserved. This publication contains information that is protected by copyright. No part may be reproduced, transmitted, transcribed, stored in a retrieval system, or translated into any language without written permission from the copyright holders.
Trademarks	The following trademarks are used in this document: <ul style="list-style-type: none">● Microsoft is a registered trademark of Microsoft Corp.● Windows, Windows 8, 10 and Explorer are trademarks of Microsoft Corp.● Apple and Mac OS are registered trademarks of Apple Inc.● Other products may be trademarks or registered trademarks of their respective manufacturers.

Safety Instructions and Approval

Safety Instructions	<ul style="list-style-type: none">● Read the installation guide thoroughly before you set up the router.● The router is a complicated electronic unit that may be repaired only by authorized and qualified personnel. Do not try to open or repair the router yourself.● Do not place the router in a damp or humid place, e.g. a bathroom.● Do not stack the routers.● The router should be used in a sheltered area, within a temperature range of +5 to +40 Celsius.● Do not expose the router to direct sunlight or other heat sources. The housing and electronic components may be damaged by direct sunlight or heat sources.● Do not deploy the cable for LAN connection outdoor to prevent electronic shock hazards.● Keep the package out of reach of children.● When you want to dispose of the router, please follow local regulations on conservation of the environment.
Warranty	We warrant to the original end user (purchaser) that the router will be free from any defects in workmanship or materials for a period of two (2) years from the date of purchase from the dealer. Please keep your purchase receipt in a safe place as it serves as proof of date of purchase. During the warranty period, and upon proof of purchase, should the product have indications of failure due to faulty workmanship and/or materials, we will, at our discretion, repair or replace the defective products or components, without charge for either parts or labor, to whatever extent we deem necessary to restore the product to proper operating condition. Any replacement will consist of a new or re-manufactured functionally equivalent product of equal value, and will be offered solely at our discretion. This warranty will not apply if the product is modified, misused, tampered with, damaged by an act of God, or subjected to abnormal working conditions. The warranty does not cover the bundled or licensed software of other vendors. Defects which do not significantly affect the usability of the product will not be covered by the warranty. We reserve the right to revise the manual and online documentation and to make changes from time to time in the contents hereof without obligation to notify any person of such revision or changes.



Declaration of Conformity

Hereby, DrayTek Corporation declares that the radio equipment type Vigor2866 series is in compliance with Directive 2014/53/EU.

The full text of the EU Declaration of Conformity is available at the following internet address:

<https://fw.draytek.com.tw/Vigor2866/Document/CE/>

Manufacturer: DrayTek Corp.

Address: No.26, Fushing Rd., Hukou, Hsinchu Industrial Park, Hsinchu 303, Taiwan

Product: Vigor2866 Series

Frequency Information for Europe area:

2.4GHz WLAN	For ac series, 2412MHz - 2472 MHz, max. TX power: 19.78dBm *1
	For ax series, 2412MHz - 2472 MHz, max. TX power: 19.86dBm *1
5GHz WLAN	For ac series, 5160MHz - 5340 MHz, max. TX power: 22.84dBm *2 5480MHz - 5720 MHz, max. TX power: 27.88dBm
	For ax series, 5160MHz - 5340 MHz, max. TX power: 22.79dBm *2 5480MHz - 5720 MHz, max. TX power: 29.78dBm
LTE	B1[1920-1980 MHz (TX); 2110-2170 MHz (RX)]; B3[1710-1785 MHz (TX); 1805-1880 MHz (RX)]; B7[2500-2570 MHz (TX); 2620-2690 MHz (RX)]; B8[880-915 MHz (TX); 925-960 MHz (RX)]; B20[832-862 MHz (TX); 791-821 MHz (RX)]; B28[703-748 MHz (TX); 758-803 MHz (RX)]; B38[2570-2620 MHz (TX); 2570-2620 MHz (RX)]; B40[2300-2400 MHz (TX); 2300-2400 MHz (RX)]*3
3G	B1[1920-1980 MHz (TX); 2110-2170 MHz (RX)]; B8[880-915 MHz (TX); 925-960 MHz (RX)] *3
	Requirements in AT/BE/BG/CZ/DZ/DK/EE/FR/DE/IS/IE/IT/EL/ES/CY/LV/LI/LT/LU/HU/MT/NL/NO/PL/PT/RO/SI/SK/TR/FI/SE/CH/HR. 5150MHz-5350MHz is for indoor use only.

(*1: for 2.4GHz WLAN model; *2: for 5GHz WLAN model; *3: for LTE model))

This product is designed for LTE, DSL and 2.4GHz /5GHz WLAN network throughout the EC region.



Declaration of Conformity

Hereby, DrayTek Corporation declares that the radio equipment type Vigor2866 is in compliance with Regulation SI 2017 No. 1206.

Manufacturer: DrayTek Corp.

Address: No. 26, Fushing Rd., Hukou, Hsinchu Industrial Park, Hsinchu 303, Taiwan

Product: Vigor2866 Wireless Series

Importer: CMS Distribution Ltd: Bohola Road, Kiltimagh, Co Mayo, Ireland

Frequency Information for UK area:

2.4GHz WLAN	For ac series, 2412MHz - 2472 MHz, max. TX power: 19.78dBm *1
	For ax series, 2412MHz - 2472 MHz, max. TX power: 19.86dBm *1
5GHz WLAN	For ac series, 5160MHz - 5340 MHz, max. TX power: 22.84dBm *2 5480MHz - 5720 MHz, max. TX power: 27.88dBm
	For ax series, 5160MHz - 5340 MHz, max. TX power: 22.79dBm *2 5480MHz - 5720 MHz, max. TX power: 29.78dBm
LTE	B1[1920-1980 MHz (TX); 2110-2170 MHz (RX)]; B3[1710-1785 MHz (TX); 1805-1880 MHz (RX)]; B7[2500-2570 MHz (TX); 2620-2690 MHz (RX)]; B8[880-915 MHz (TX); 925-960 MHz (RX)]; B20[832-862 MHz (TX); 791-821 MHz (RX)]; B28[703-748 MHz (TX); 758-803 MHz (RX)]; B38[2570-2620 MHz (TX); 2570-2620 MHz (RX)]; B40[2300-2400 MHz (TX); 2300-2400 MHz (RX)]*3
3G	B1[1920-1980 MHz (TX); 2110-2170 MHz (RX)]; B8[880-915 MHz (TX); 925-960 MHz (RX)] *3
	Requirements in UK. 5150MHz-5350MHz is for indoor use only.

(*1: for 2.4GHz WLAN model; *2: for 5GHz WLAN model; *3: for LTE model)

This product is designed for LTE, DSL and 2.4GHz /5GHz WLAN network use in the UK & Ireland.

*The external power supply used for each product will be model dependent.

	1	2	3	4	5	6	7	8	9
A Manufacturer	CWT	CWT	CWT	CWT	CWT	APD	APD	APD	APD
B Address	No. 222, Sec. 2, Nankan Rd., Lujhu Township, Taoyuan County 338, Taiwan	No. 222, Sec. 2, Nankan Rd., Lujhu Township, Taoyuan County 338, Taiwan	No. 222, Sec. 2, Nankan Rd., Lujhu Township, Taoyuan County 338, Taiwan	No. 222, Sec. 2, Nankan Rd., Lujhu Township, Taoyuan County 338, Taiwan	No. 222, Sec. 2, Nankan Rd., Lujhu Township, Taoyuan County 338, Taiwan	No.5, Lane 83, Lung-Sou St., Taoyuan City 330, Taiwan	No.5, Lane 83, Lung-Sou St., Taoyuan City 330, Taiwan	No.5, Lane 83, Lung-Sou St., Taoyuan City 330, Taiwan	No.5, Lane 83, Lung-Sou St., Taoyuan City 330, Taiwan
C Model identifier	2ABB012F UK 2ABB012F EU	2ABB018F UK 2ABB018F EU	2ABL024F UK 2ABL024F EU	2ABL030F UK 2ABL030F EU	2ABN036F UK 2ABN036F EU	WA-12M12FG WA-12M12FK	WB-18D12FG WB-18D12FK	WA-24Q12FG WA-24Q12FK	WA-36A12FG WA-36A12FK
D Input voltage	100-240V	100-240V	100-240V	100-240V	100-240V	100-240V	100-240V	100-240V	100-240V
E Input AC frequency	50/60Hz	50/60Hz	50/60Hz	50/60Hz	50/60Hz	50/60Hz	50/60Hz	50/60Hz	50/60Hz
Output voltage DC	12.0V	12.0V	12.0V	12.0V	12.0V	12.0V	12.0V	12.0V	12.0V
F Output current	1.0A	1.5A	2.0A	2.5A	3.0A	1.0A	1.5A	2.0A	3.0A
G Output power	12.0W	18.0W	24.0W	30.0W	36.0W	12.0W	18.0W	24.0W	36.0W
H Average active efficiency	84.9%	86.2%	87.6%	87.8%	89.8%	83.7%	85.4%	88.6%	88.2%
I Efficiency at low load 10%	73.6%	78.0%	81.3%	83.3%	83.7%	74.5%	80.5%	86.4%	85.4%
J No-load power consumption	0.07W	0.07W	0.07W	0.07W	0.07W	0.07W	0.10W	0.07W	0.10W

External power supply (Power Adapter) information. For more update, please visit www.draytek.com.





Regulatory Information

Federal Communication Commission Interference Statement

This equipment has been tested and found to comply with the limits for a Class B digital device, pursuant to Part 15 of the FCC Rules. These limits are designed to provide reasonable protection against harmful interference in a residential installation. This equipment generates, uses and can radiate radio frequency energy and, if not installed and used in accordance with the instructions, may cause harmful interference to radio communications. However, there is no guarantee that interference will not occur in a particular installation. If this equipment does cause harmful interference to radio or television reception, which can be determined by turning the equipment off and on, the user is encouraged to try to correct the interference by one of the following measures:

- Reorient or relocate the receiving antenna.
- Increase the separation between the equipment and receiver.
- Connect the equipment into an outlet on a circuit different from that to which the receiver is connected.
- Consult the dealer or an experienced radio/TV technician for help.

This device complies with Part 15 of the FCC Rules. Operation is subject to the following two conditions:

- (1) This device may not cause harmful interference, and
- (2) This device may accept any interference received, including interference that may cause undesired operation.

User Manual Information Agreement

This equipment complies with Part 68 of the FCC rules. Located on the equipment is a label that contains, among other information, the ACTA registration number and ringer equivalence number (REN.) If requested, this information must be provided to the telephone company.

The REN is used to determine the quantity of devices which may be connected to the telephone line. Excessive REN's on the telephone line may result in the devices not ringing in response to an incoming call. In most, but not all areas, the sum of the REN's should not exceed five (5.0). To be certain of the number of devices that may be connected to the line, as determined by the total REN's contact the telephone company to determine the maximum REN for the calling area.

This equipment cannot be used on the telephone company-provided coin service. Connection to Party Line Service is subject to State Tariffs.

If this equipment causes harm to the telephone network, the telephone company will notify you in advance that temporary discontinuance of service may be required. If advance notice isn't practical, the telephone company will notify the customer as soon as possible. Also, you will be advised of your right to file a complaint with the FCC if you believe it is necessary.

The telephone company may make changes in its facilities, equipment, operations, or procedures that could affect the operation of the equipment. If this happens, the telephone company will provide advance notice in order for you to make the necessary modifications in order to maintain uninterrupted service.

It is recommended that the customer install an AC surge arrester in the AC outlet to which this device is connected. This is to avoid damaging the equipment caused by local lightning strikes and other electrical surges.

USA Local Representative	Company name	ABP International Inc.		
	Address	13988 Diplomat Drive Suite 180 Dallas TX 75234		
	ZIP Code	75234	E-mail	rmesser@abptech.com
	Contact Person	Mr. Robert Messer	Tel.	19728311600

Caution:

Any changes or modifications not expressly approved by the grantee of this device could void the user's authority to operate the equipment.

Any changes or modifications not expressly approved by the party responsible for compliance could void the user's authority to operate this equipment.

This transmitter must not be co-located or operating in conjunction with any other antenna or transmitter.

Radiation Exposure Statement: This equipment complies with FCC radiation exposure limits set forth for an uncontrolled environment. This equipment should be installed and operated with minimum distance 20cm between the radiator & your body.

The antenna/transmitter should be kept at least 20 cm away from human body.

Table of Contents

1. Package Content	1
2. Panel Explanation.....	2
2.1 Vigor2866L	2
2.2 Vigor2866ac / Vigor2866 ax / Vigor2866Lac.....	4
2.3 Vigor2866Vac	8
3. Hardware Installation	11
3.1 Network Connection	11
3.2 Wall-Mounted Installation	12
4. Software Configuration	13
4.1 Quick Start Wizard for Network Connection.....	13
5. Customer Service	19
Be a Registered Owner	19
Firmware & Tools Updates	19

1. Package Content

Take a look at the package content. If there is anything missed or damaged, please contact DrayTek or dealer immediately. Besides, the content is subject to the real package.



Vigor Router

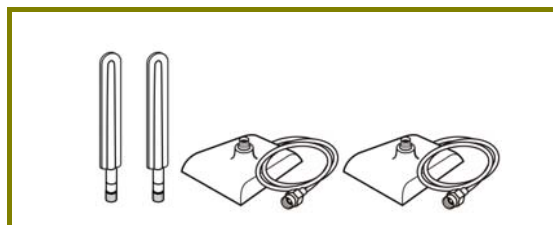

Antenna + Socket (L models)

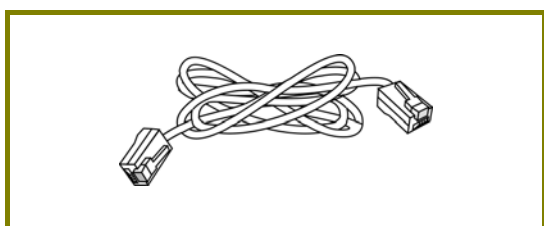

RJ-45 Cable (Ethernet)



RJ-11 to RJ-11 Cable or RJ-11 to RJ-45 Cable

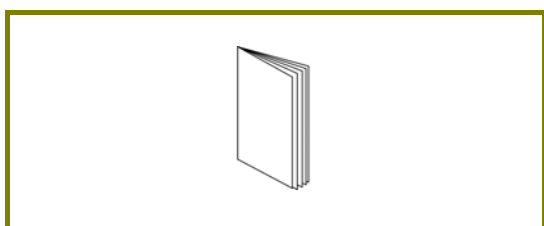

Quick Start Guide



Antenna (wireless models)

The type of the power adapter depends on the country that the router will be installed. * The maximum power consumption is *28 Watt*.

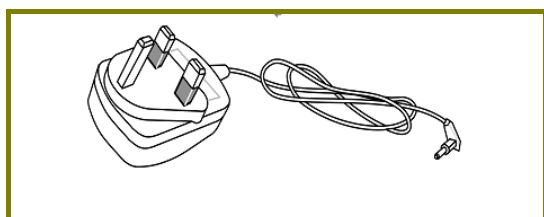

UK-type Power Adapter

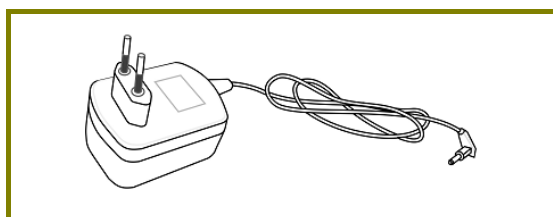

EU-type Power Adapter

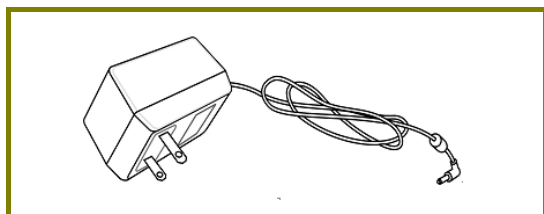

USA/Taiwan-type Power Adapter

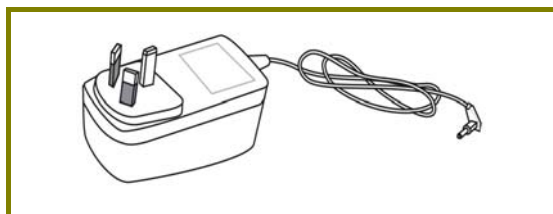

AU/NZ-type Power Adapter

2. Panel Explanation

2.1 Vigor2866L

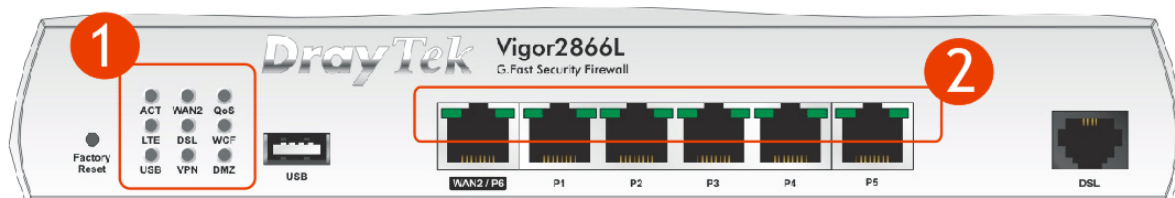

No.	LED	Status	Explanation
(1)	ACT	Off	The router is powered off.
		Blinking	The router is powered on and running normally.
	WAN2	On	Internet connection is ready.
		Off	Internet connection is not ready.
		Blinking	The data is transmitting.
	QoS	On	The QoS function is active.
		Off	The QoS function is inactive.
	LTE	On	LTE device is connected and ready for use.
		Off	LTE device is not detected, or has serious problem (e.g., no SIM card, SIM pin error, SIM deactivated, and etc.).
		Blinking	Slowly: LTE device is in dialing up. Quickly: The data is transmitting.
	DSL	On	The router is ready to access Internet through DSL link.
		Blinking	Slowly: The DSL connection is ready. Quickly: The connection is training.
	WCF	On	The Web Content Filter is active. (It is enabled from Firewall >> General Setup).
		Off	WCF is disabled.
	USB	On	USB device is connected and ready for use.
		Off	No USB device is connected.
		Blinking	The data is transmitting.
	VPN	On	The VPN tunnel is active.
Off		VPN services are disabled	
Blinking		Traffic is passing through VPN tunnel.	
DMZ	On	The DMZ function is enabled.	
	Off	The DMZ function is disabled.	
	Blinking	The data is transmitting.	
(2)	WAN2 / P6		
	Left LED	On	The port is connected.
		Off	The port is disconnected.
		Blinking	The data is transmitting.

Right LED	On	The port is connected with 1000Mbps.
	Off	The port is connected with 10/100Mbps.
LAN P1-P5		
Left LED	On	The port is connected.
	Off	The port is disconnected.
	Blinking	The data is transmitting.
Right LED	On	The port is connected with 1000Mbps.
	Off	The port is connected with 10/100Mbps

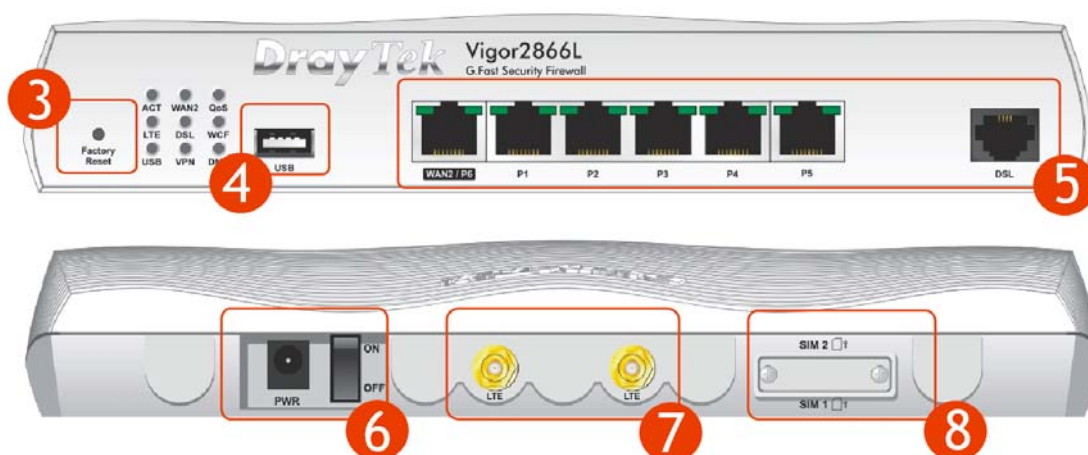

No.	Interface	Description
(3)	Factory Reset	Restore the default settings. Usage: Turn on the router (ACT LED is blinking). Press the hole and keep for more than 5 seconds. When you see the ACT LED begins to blink rapidly than usual, release the button. Then the router will restart with the factory default configuration.
(4)	USB	Connector for a USB device (for 3G/4G USB Modem or printer or thermometer).
(5)	WAN2 / P6	Connector for local network devices or modem for accessing Internet. It is a switchable port. It can be used for LAN connection or WAN connection according to the settings configured in WUI.
	LAN P1-P5	Connectors for local network devices.
	DSL	Connector for accessing the Internet.
(6)	PWR	Connector for a power adapter.
	ON/OFF	Power Switch.
(7)		Connector for installing LTE antennas.
(8)	SIM 2/1	Slots for installing SIM card.

2.2 Vigor2866ac / Vigor2866 ax / Vigor2866Lac

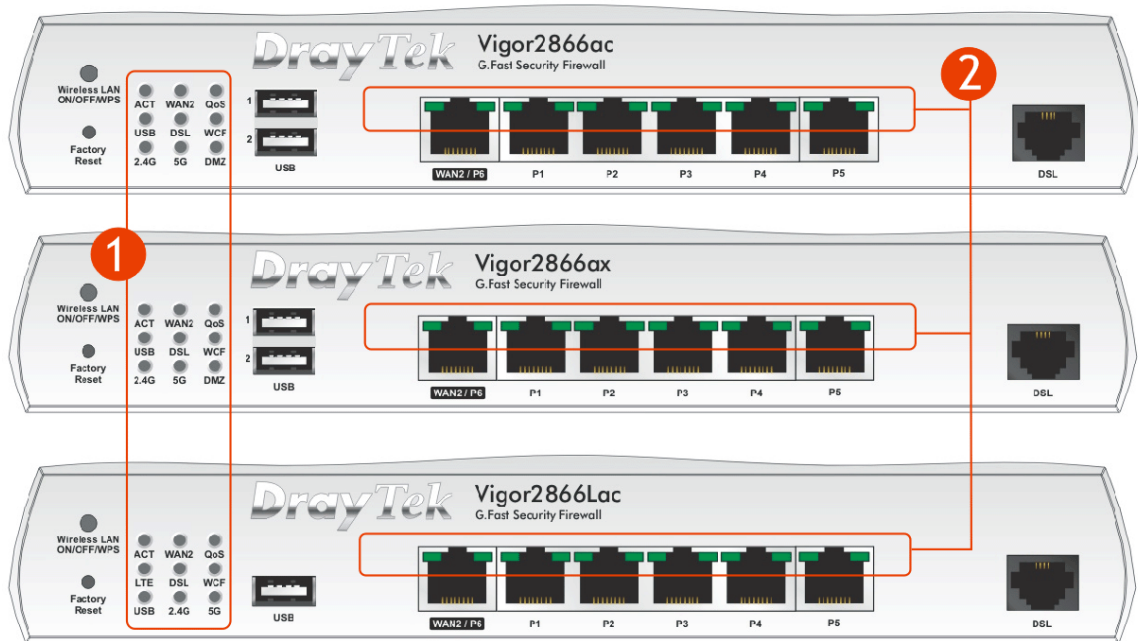

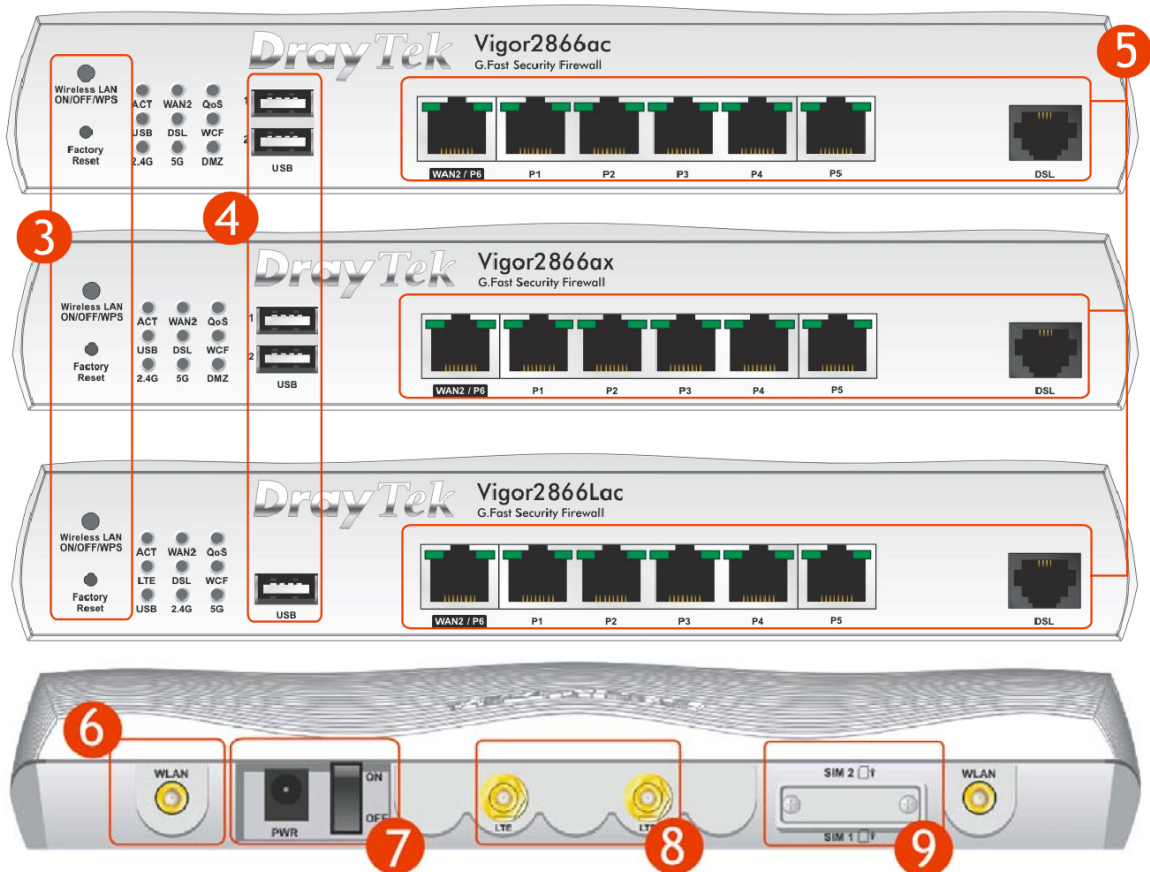

No.	LED	Status	Explanation
(1)	ACT	Off	The router is powered off.
		Blinking	The router is powered on and running normally.
	WAN2	On	Internet connection is ready.
		Off	Internet connection is not ready.
		Blinking	The data is transmitting.
	QoS	On	The QoS function is active.
		Off	The QoS function is inactive.
	USB	On	USB device is connected and ready for use.
		Off	No USB device is connected.
		Blinking	The data is transmitting.
	LTE	On	LTE device is connected and ready for use.
		Off	LTE device is not detected, or has serious problem (e.g., no SIM card, SIM pin error, SIM deactivated, and etc.).
		Blinking	Slowly: LTE device is in dialing up. Quickly: The data is transmitting.
	DSL	On	The router is ready to access Internet through DSL link.
		Blinking	Slowly: The DSL connection is ready. Quickly: The connection is training.
	WCF	On	The Web Content Filter is active. (It is enabled from Firewall >> General Setup).
		Off	WCF is disabled.
	2.4G/5G	On	2.4G/5G: Wireless access point with bandwidth of 2.4GHz/5GHz is ready.

			WLAN: Wireless access point is ready.
		Off	Wireless function is disabled.
		Blinking	It will blink slowly while wireless traffic goes through. ACT and WLAN LEDs blink quickly and simultaneously when WPS is working, and will return to normal condition after two minutes. (You need to setup WPS within 2 minutes.)
	DMZ	On	The DMZ function is enabled.
		Off	The DMZ function is disabled.
		Blinking	The data is transmitting.
(2)	WAN2 / P6		
	Left LED	On	The port is connected.
		Off	The port is disconnected.
		Blinking	The data is transmitting.
	Right LED	On	The port is connected with 1000Mbps.
		Off	The port is connected with 10/100Mbps.
	LAN P1-P5		
	Left LED	On	The port is connected.
		Off	The port is disconnected.
		Blinking	The data is transmitting.
	Right LED	On	The port is connected with 1000Mbps.
		Off	The port is connected with 10/100Mbps



No.	Interface	Description
(3)	Wireless LAN ON/OFF/WPS	<p>Wireless band will be switched /changed according to the button pressed and released. For example,</p> <ul style="list-style-type: none"> ● 2.4G (On) and 5G (On) - in default. ● 2.4G (Off) and 5G (On) - pressed and released the button once. ● 2.4G (On) and 5G (Off) - pressed and released the button twice. ● 2.4G (Off) and 5G (Off) - pressed and released the button three times. <p>When WPS function is enabled by web user interface, press this button for more than 2 seconds to wait for client's device making network connection through WPS.</p>
	Factory Reset	<p>Restore the default settings. Usage: Turn on the router (ACT LED is blinking). Press the hole and keep for more than 5 seconds. When you see the ACT LED begins to blink rapidly than usual, release the button. Then the router will restart with the factory default configuration.</p>
(4)	USB1-2 / USB	<p>Connector for a USB device (for 3G/4G USB Modem or printer or thermometer).</p>
(5)	WAN2 / P6	<p>Connector for local network devices or modem for accessing Internet.</p> <p>The port "WAN2 / P6" is switchable. It can be used for LAN</p>

		connection or WAN connection according to the settings configured in WUI.
	LAN P1-P5	Connecters for local network devices.
	DSL	Connector for accessing the Internet.
(6)		Connector for installing WLAN antennas. (For ac model)
(7)	PWR	Connector for a power adapter.
	ON/OFF	Power Switch.
(8)		Connector for installing LTE antennas. (For L model).
(9)	SIM 2/1	Slots for installing SIM card. (For L model).

2.3 Vigor2866Vac

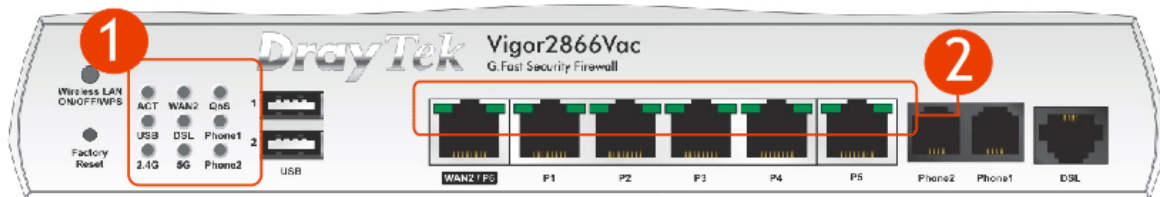

No.	LED	Status	Explanation
(1)	ACT	Off	The router is powered off.
		Blinking	The router is powered on and running normally.
	WAN2	On	Internet connection is ready.
		Off	Internet connection is not ready.
		Blinking	The data is transmitting.
	QoS	On	The QoS function is active.
		Off	The QoS function is inactive.
	USB	On	USB device is connected and ready for use.
		Off	No USB device is connected.
		Blinking	The data is transmitting.
	DSL	On	The router is ready to access Internet through DSL link.
		Blinking	Slowly: The DSL connection is ready. Quickly: The connection is training.
	Phone1/2	On	The phone connected to this port is off-hook.
		Off	The phone connected to this port is on-hook.
		Blinking	A phone call comes.
2.4G/5G	On	2.4G/5G: Wireless access point with bandwidth of 2.4GHz/5GHz is ready. WLAN: Wireless access point is ready.	
	Off	Wireless function is disabled.	
	Blinking	It will blink slowly while wireless traffic goes through. ACT and WLAN LEDs blink quickly and simultaneously when WPS is working, and will return to normal condition after two minutes. (You need to setup WPS within 2 minutes.)	
(2)	WAN2 / P6		
	Left LED	On	The port is connected.
		Off	The port is disconnected.
		Blinking	The data is transmitting.
	Right LED	On	The port is connected with 1000Mbps.
		Off	The port is connected with 10/100Mbps.
LAN P1-P5			

Left LED	On	The port is connected.
	Off	The port is disconnected.
	Blinking	The data is transmitting.
Right LED	On	The port is connected with 1000Mbps.
	Off	The port is connected with 10/100Mbps

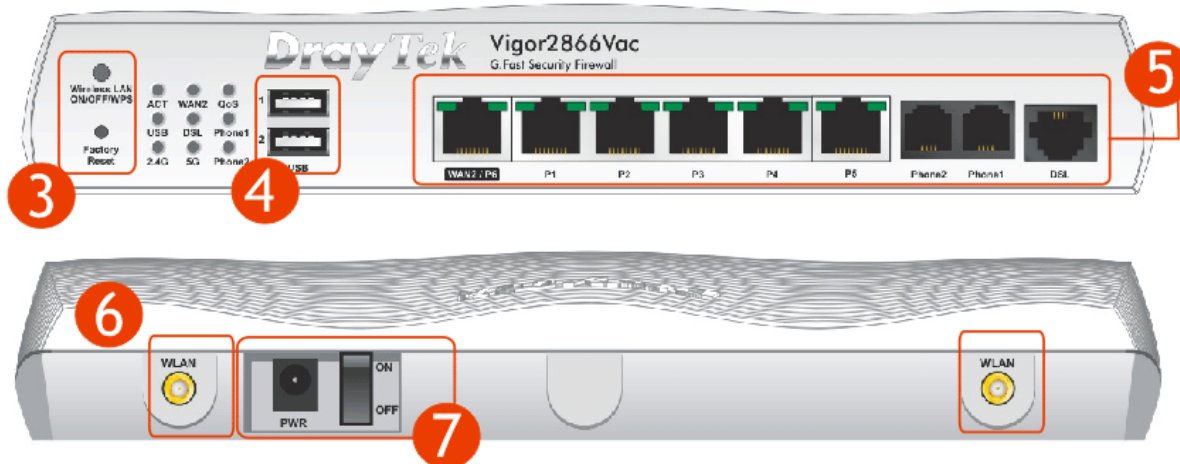

No.	Interface	Description
(3)	Wireless LAN ON/OFF/WPS	<p>Wireless band will be switched /changed according to the button pressed and released. For example,</p> <ul style="list-style-type: none"> ● 2.4G (On) and 5G (On) - in default. ● 2.4G (Off) and 5G (On) - pressed and released the button once. ● 2.4G (On) and 5G (Off) - pressed and released the button twice. ● 2.4G (Off) and 5G (Off) - pressed and released the button three times. <p>When WPS function is enabled by web user interface, press this button for more than 2 seconds to wait for client's device making network connection through WPS.</p>
	Factory Reset	<p>Restore the default settings. Usage: Turn on the router (ACT LED is blinking). Press the hole and keep for more than 5 seconds. When you see the ACT LED begins to blink rapidly than usual, release the button. Then the router will restart with the factory default configuration.</p>
(4)	USB	<p>Connector for a USB device (for 3G/4G USB Modem or printer or thermometer).</p>
(5)	WAN2 / P6	<p>Connector for local network devices or modem for accessing Internet. It is a switchable port. It can be used for LAN connection or WAN connection according to the settings configured in WUI.</p>
	LAN P1-P5	<p>Connecters for local network devices.</p>
	Phone 1/2	<p>Connector for analog phone(s).</p>

	DSL	Connector for accessing the Internet.
(6)		Connector for installing WLAN antennas.
(7)	PWR	Connector for a power adapter.
	ON/OFF	Power Switch.

3. Hardware Installation

This section will guide you to install the router through hardware connection and configure the router's settings through web browser.

Before starting to configure the router, you have to connect your devices correctly. (For the hardware connection, we take "ac" model as an example.)

3.1 Network Connection

1. Connect the DSL interface to the land line jack with a DSL line cable, or Connect the cable Modem/DSL Modem/Media Converter to the WAN port of router with Ethernet cable (RJ-45).
2. Connect one end of an Ethernet cable (RJ-45) to one of the LAN ports of the router and the other end of the cable (RJ-45) into the Ethernet port on your computer.
3. Connect one end of the power adapter to the router's power port on the rear panel, and the other side into a wall outlet.
4. Power on the device by pressing down the power switch on the rear panel.
5. The system starts to initiate. After completing the system test, the **ACT** LED will light up and start blinking. (For the detailed information of LED status, please refer to section 2. Panel Explanation)

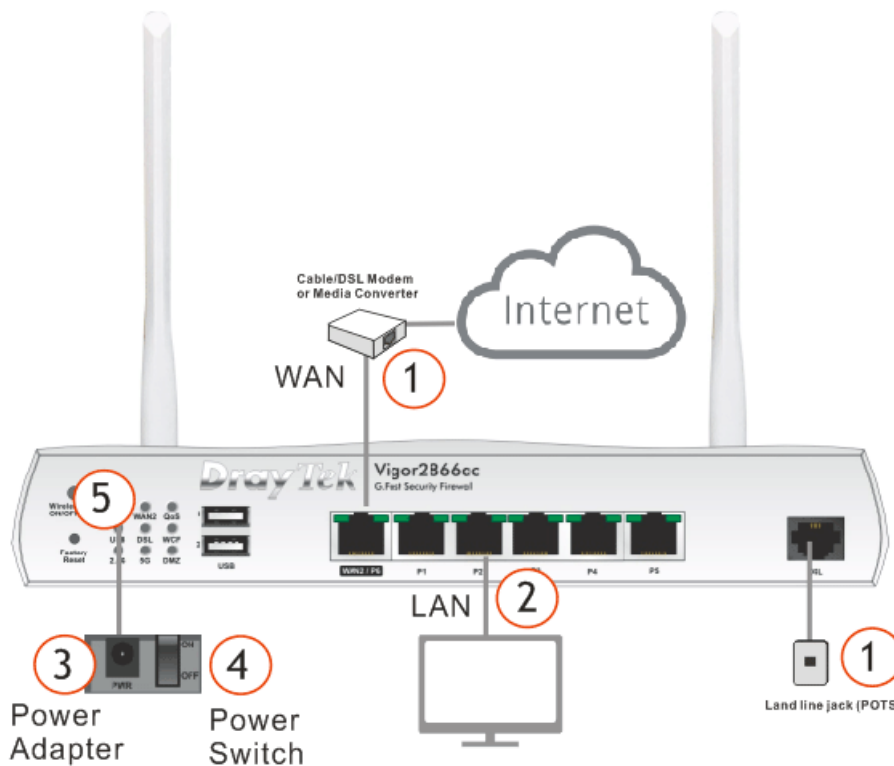

3.2 Wall-Mounted Installation

Vigor router has keyhole type mounting slots on the underside.

1. Drill two holes on the wall. The distance between the holes shall be 168mm.
2. Fit screws into the wall using the appropriate type of wall plug.

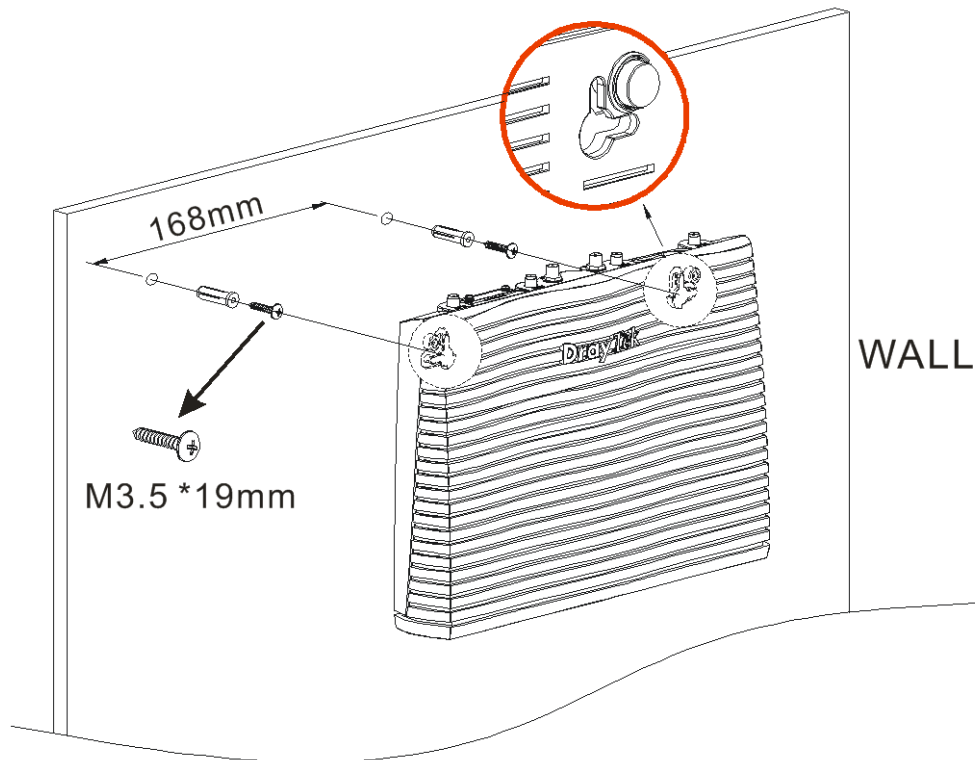

Note

The recommended drill diameter shall be 6.5mm (1/4").

3. When you finished about procedure, the router has been mounted on the wall firmly.

4. Software Configuration

To access Internet, please finish basic configuration after completing the hardware installation.

4.1 Quick Start Wizard for Network Connection

The **Quick Start Wizard** is designed for you to easily set up your router for Internet access. You can directly access the **Quick Start Wizard** via Web User Interface. Make sure your PC connects to the router correctly.



Note

You may either simply set up your computer to get IP dynamically from the router or set up the IP address of the computer to be the same subnet as the **default IP address of Vigor router 192.168.1.1**. For the detailed information, please refer to - Trouble Shooting of the user's guide.

Open a web browser on your PC and type **http://192.168.1.1**. A pop-up window will open to ask for username and password. Please enter "admin/admin" as the Username/Password and click **Login**.

DrayTek **Vigor2866 Series**

Login

Username

Password

Language ▼

Login

Security Warning: You are logging in without encryption which is not recommended. To login securely [click here](#).

Copyright© 2000-2021 DrayTek Corp. All Rights Reserved.



Note

If you fail to access to the web configuration, please go to "Trouble Shooting" on User's Guide for detecting and solving your problem.

Now, the Main Screen will pop up. Click Wizards>>Quick Start Wizard.

DrayTek Vigor2866 Series

Dashboard

System Information

Model Name	Vigor2866ac	System Uptime	0 day 00:01:52
Router Name	MK2866	Current Time	Fri Oct 14 2022 14:24:35
Firmware Version	4.4.1	Build Date/Time	Oct 13 2022 15:50:48
DSL Version	1272104 HW: A	LAN MAC Address	14-49-BC-02-36-50

IPv4 LAN Information

LAN	IP Address	DHCP	LAN	IP Address	DHCP
LAN1	192.168.88.1/24	v	LAN2	192.168.87.1/24	v
LAN3	192.168.3.1/24	v	LAN4	192.168.4.1/24	v
LAN5	192.168.5.1/24	v	LAN6	192.168.6.1/24	v
LAN7	192.168.7.1/24	v	LAN8	192.168.8.1/24	v
DMZ PORT	192.168.254.1/24	v	IP Routed Subnet	192.168.0.1/24	v

IPv4 Internet Access

WAN	Line / Mode	IP Address	MAC Address	Up Time
WAN1	VDSL2 / PPPoE	Disconnected	14-49-BC-02-36-51	0 day 00:00:00
WAN2	Ethernet / DHCP Client	10.0.19.3	14-49-BC-02-36-52	0 day 00:00:20
WAN3	Wireless 2.4G / ---	Disconnected	12-59-BC-02-36-50	0 day 00:00:00
WAN4	Wireless 5G / ---	Disconnected	12-49-BC-02-36-50	0 day 00:00:00
WAN5	USB / ---	Disconnected	14-49-BC-02-36-55	0 day 00:00:00
WAN6	USB / ---	Disconnected	14-49-BC-02-36-56	0 day 00:00:00

Interface

Interface	Connected	Down Stream	Up Stream
WAN	Connected	1	0Kbps / 0Kbps
LAN	Connected	0	0
WLAN	Connected	0	0
WLAN5G	Connected	0	0
USB	Connected	0	0

Security

VPN	Connected	0	Remote Dial-In User / LAN to LAN
MyVigor	Activate	3	Web Content Filter, APP Enforcement, DrayDNS License
DoS	Attack Detected		
RootCA			



Note The home page will change slightly in accordance with the router you have. Here we take Vigor2866ac as an status.

If your router can be under an environment with high speed NAT, the configuration provide here can help you to deploy and use the router quickly. The first screen of **Quick Start Wizard** is entering login password. After typing the password, please click **Next**.

Quick Start Wizard

Enter login password

Please enter an alpha-numeric string as your **Password** (Max 23 characters).

Old Password

New Password

Confirm Password

Hint: If you want to keep the password unchanged, leave the password blank and press "Next" button to skip this process.

< Back Next > Finish Cancel

On the next page as shown below, please select the WAN interface that you use. If DSL interface is used, please choose WAN1; if Ethernet interface is used, please choose WAN2; if wireless 2.4G/5G connection is used, please choose WAN3 or WAN4; if 3G USB modem is used, please choose WAN5 or WAN6. Then click **Next** for next step. Each WAN interface will bring up specific configuration page. Here, we take **WAN1** as an example.

Quick Start Wizard

WAN Interface

WAN Interface:	WAN1 ▾
Display Name:	<input type="text"/>
Physical Mode:	ADSL / VDSL2 / G.fast
DSL Mode:	Auto ▾
Physical Type:	Auto negotiation ▾
VLAN Tag insertion (ADSL):	Disable ▾
VLAN Tag insertion (VDSL2):	Disable ▾

Click **Next** to go to the following page. You have to select the appropriate Internet access type according to the information from your ISP. For example, you should select PPPoA mode if the ISP provides you PPPoA interface. In addition, the field of **For ADSL Only** will be available only when ADSL is detected. Then click **Next** for next step.

Quick Start Wizard

Connect to Internet

WAN 1	
Protocol	MPoA / Static or Dynamic IP ▾
For ADSL Only:	
Encapsulation	1483 Bridged IP LLC ▾
VPI	<input type="text" value="0"/> <input data-bbox="845 1556 957 1590" type="button" value=" Auto detect "/>
VCI	<input type="text" value="33"/>
Fixed IP	<input type="radio"/> Yes <input checked="" type="radio"/> No(Dynamic IP)
IP Address	<input type="text"/>
Subnet Mask	<input type="text"/>
Default Gateway	<input type="text"/>
Primary DNS	<input type="text" value="8.8.8.8"/>
Second DNS	<input type="text" value="8.8.4.4"/>

PPPoE/PPPoA

1. Choose WAN1 as WAN Interface and click the Next button; you will get the following page.

Quick Start Wizard

Connect to Internet

WAN 1	
Protocol	PPPoE / PPPoA
For ADSL Only:	
Encapsulation	PPPoE LLC/SNAP
VPI	0 <input type="button" value="Auto detect"/>
VCI	33
Fixed IP	<input type="radio"/> Yes <input checked="" type="radio"/> No(Dynamic IP)
IP Address	<input type="text"/>
Subnet Mask	<input type="text"/>
Default Gateway	<input type="text"/>
Primary DNS	8.8.8.8
Second DNS	8.8.4.4

 >

2. After finished the above settings, simply click Next.

Quick Start Wizard

Set PPPoE / PPPoA

WAN 1	
Service Name (Optional)	CHTI
Username	77494727@hinet.net
Password	*****
Confirm Password	*****

 >

3. Please manually enter the Username/Password provided by your ISP. Then click **Next** for viewing summary of such connection.

Quick Start Wizard

Please confirm your settings:

WAN Interface:	WAN1
Physical Mode:	ADSL / VDSL2
VPI:	0
VCI:	33
Protocol / Encapsulation:	PPPoE / LLC
Fixed IP:	No
Primary DNS:	8.8.8.8
Secondary DNS:	8.8.4.4

4. Click **Finish**. A page of **Quick Start Wizard Setup OK!!!** will appear. Then, the system status of this protocol will be shown.
5. Now, you can enjoy surfing on the Internet.

MPoA / Static or Dynamic IP

1. Choose WAN1 as WAN Interface and click the Next button; you will get the following page.

Quick Start Wizard

Connect to Internet

WAN 1
Protocol: MPoA / Static or Dynamic IP ▾

For ADSL Only:
Encapsulation: 1483 Bridged IP LLC ▾
VPI: 0 Auto detect
VCI: 33

Fixed IP: Yes No(Dynamic IP)

IP Address:

Subnet Mask:

Default Gateway:

Primary DNS: 8.8.8.8

Second DNS: 8.8.4.4

< Back Next > Finish Cancel

2. Please type in the IP address/mask/gateway information originally provided by your ISP. Then click Next for viewing summary of such connection.

Quick Start Wizard

Please confirm your settings:

WAN Interface:	WAN1
Physical Mode:	ADSL / VDSL2
VPI:	0
VCI:	33
Protocol / Encapsulation:	PPPoE / LLC
Fixed IP:	No
Primary DNS:	8.8.8.8
Secondary DNS:	8.8.4.4

< Back Next > Finish Cancel

3. Click Finish. A page of Quick Start Wizard Setup OK!!! will appear. Then, the system status of this protocol will be shown.
4. Now, you can enjoy surfing on the Internet.

5. Customer Service

If the router cannot work correctly after trying many efforts, please contact your dealer for further help right away. For any questions, please feel free to send e-mail to support@draytek.com.

Be a Registered Owner

Web registration is preferred. You can register your Vigor router via <https://myvigor.draytek.com>.

Firmware & Tools Updates

Due to the continuous evolution of DrayTek technology, all routers will be regularly upgraded. Please consult the DrayTek web site for more information on newest firmware, tools and documents.

<https://www.draytek.com>